

Article number: 20477B20MT

Description: E+G Clamp mounting - GN 477-B20-MT

Measures

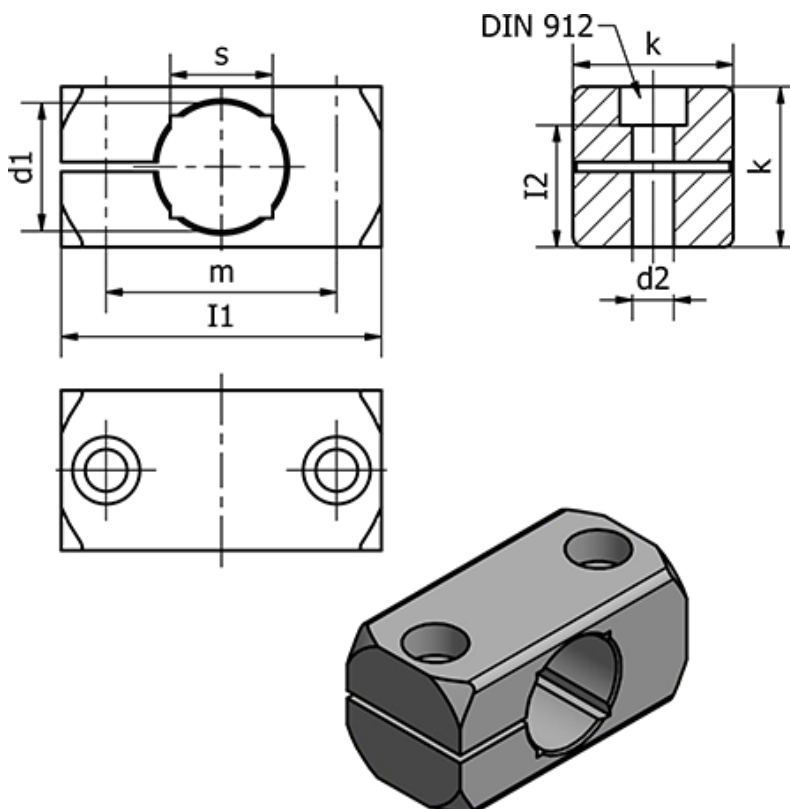

Clamping kit for d2 = GN 511-M6-32

Clamping kit for d3 = -

d1 = 20
d2 = M6
l1 = 50
l2 = 14
k = 25
m = 36

s = 16

Weight (g) = 52